

Article Info

Received: 23 Jan 2019 | Revised Submission: 20 Mar 2019 | Accepted: 10 Apr 2019 | Available Online: 15 Jun 2019

Study and First Law Analysis of Gas Turbine-HRSG-ORC Co-Generation System with Change in Atmospheric Temperature

Priyanshu Thakur* and P. V. Ram Kumar**

ABSTRACT

Gas turbine cogeneration system integrated with heat recovery steam generator and organic Rankine cycle provides an effective measure of waste heat recovery from exhaust gasses of gas turbine. The numerous study conducted to understand the variation in the performance of the integrated system has been done and the variation of performance with parameters such as turbine inlet temperature, compression ratio mass flow rate etc., has been carried out. The present paper investigates the variation in the performance of the system with change in the surrounding temperature. The paper provides the detailed first law analysis of the system and compares the first law efficiency obtained at different surrounding temperature to justify the location of use of the integrated system.

Keywords: Gas Turbine; Heat Recovery Steam Geenrator; Organic Cycle; First Law Efficiencny.

1.0 Introduction

With growing energy demand and issues of rise in environmental pollution at an unprecedented, the efficient utilization of available resources has become an issue of eminence importance. This bring into focus how effectively available resources can be managed without compromising the needs of the future generation thought sustainable development. Cogeneration system forms a part of such efficient utilisation of resources by ensuring the waste heat recovery from the available energy resource. The cogeneration system is defined in general terms as the process of producing more than one form of energy by utilising the same heating source such as thermal and electrical energy together from fossil fuels. Formally, World Alliance for Decentralisation Energy defines it as, "Process of producing both electrical and usable thermal energy (heating or cooling) at high efficiency and near the point use". And The Bureau of Energy Efficiency India defines cogeneration as "Sequential generation of two different form of energy from a single primary source, typically mechanical and thermal energy." [1]. Cogeneration system has been an integral form of

energy generation dating backs to 1880 when electricity was not a primary source of energy and still continues to play an eminent role in the efficient energy management. The paper focus on one of such cogeneration system with gas turbine (GT) as prime mover and organic Ranking (ORC) present as bottoming cycle for waste heat recovery. ORC works in the same principle as common steam Rankine cycle. The only difference lies in the working fluid. ORC uses organic fluids or refrigerants as working fluid. The lower heat of vaporisation of these organic fluid make them suitable for working with a temperature source below 230°C [2]. A lot of work has been conducted and good results are obtained in field of research for increasing the performance of the performance of ORC system. Researchers has examined different organic fluids for their performance. However over the recent years ORC as a bottom cycle for gas turbine cogeneration has been studied extensively. Khaljani M. et al, [3] has done one of the most detailed analysis of the system. In his work the energy, exergy and exergo-economic analysis has been carried out with R123 as the working fluid, parametric study has been done to understand the effect of various design variable on

*Corresponding Author: Department of Mechanical Engineering, Delhi Technological University, National Capital Region, New Delhi-110042, India (E-mail: priyanshu6995@gmail.com)

**Department of Mechanical Engineering, Delhi Technological University, National Capital Region, New Delhi-110042, India (E-mail: pvrnce@gmail.com)

the change in efficiency, cost and its impact on environment. Ahmadi et al., [4] in his work has used integration ORC for tri-generation purpose, his work has shown combustion chamber and heat exchangers as two main source of irreversibility and has established through parametric study that compression ratio (r_p), turbine inlet temperature (TIT) and turbine isentropic efficiency are the parameters that affect the performance of the system significantly. Yari M. et al., [5] in has done a comparative study ORC system with regeneration, internal heat exchanger, and simple ORC to obtain higher efficiency. The work done in [5] has been taken as the base for validation of ORC system taken in [3].

This paper, however provide a different parametric study of the system for understanding the change in system behaviour with respect to surrounding temperature along with detailed first law analysis of the system through engineering equation solver software. The current system is validated by the results obtained in the [4] and this work open the area for the further work in mapping of different refrigerant at global level with respect to the surrounding temperature.

2.0 System Description

The Schematic Diagram of the GT-HSRG-ORC is given in Figure 1. It consists of the top cycle of GT and bottoming cycle of ORC. The ambient air at point 1, with pressure of 1 bar and temperature of 298.15 K, is compressed in air compressor. Then compressed air goes into air pre-heater and come out at a temperature of 850 K. In the combustion chamber, the fuel is injection pressure is at 12 bar to the incoming hot air from air pre-heater and combustion happens. After combustion the gases with a temperature of 1520 K then expand in the gas turbine and produce power of 30 MW [3]. To recover the energy of exhaust gases, hot gases after passing through the air pre-heater, are fed into a heat recovery steam generator. In the heat recovery steam generator, water with a pressure of 35 bar and temperature of 298.15 K enters the heat recovery steam generator and leaves it as saturated steam at the same pressure. Exhaust gases then enter to the evaporator where exchange heat with a bottoming cycle. ORC has five main components of the pump,

the internal heat exchanger, evaporator, turbine and condenser. Organic working fluid in a saturated liquid phase is pumped to high pressure. After being heated in the internal heat exchanger enters the evaporator to receive the energy of exhaust gases and become saturated vapour. Afterwards, the working fluid with higher enthalpy enters turbine to produce power and expands to the condenser pressure. Superheated fluid after passing internal heat exchanger enters condenser and is condensed to saturated liquid phase.

3.0 Modelling

Fig 1: Schematic Diagram of GT-HRSG/ORC System [4]

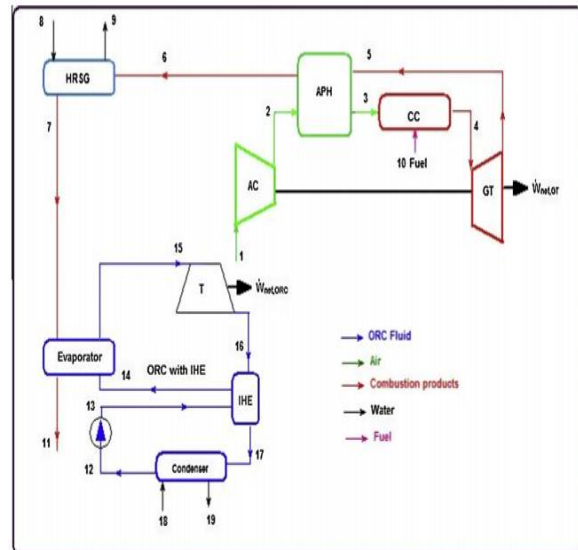

The thermodynamic modelling as well as energetic relations of the components of gas turbine cycle according to the relations given in [6], and HRSG according to the relations given in [7] and components of ORC according to the relations given in [5]. Table 1 gives the energy balance equation for various equipments of the cogeneration system.

Table 1: Energy Balance Equations GT-HRSG-ORC System [5-7]

Component	Energy Equation
Air compressor	$\eta_{ac} = \frac{(h_{2s} - h_1)}{h_2 - h_1}$ $\dot{W}_{AC} = m_{air}(h_2 - h_1)$
Air pre-heater	$h_3 - h_{2a} = (1 + \tau)(h_{5a} - h_6)$

Combustion chamber	$-0.02\tau LHV_{CH_4} + h_a + \tau h_p - (1 + \tau)h_p$
Gas turbine	$\eta_{GT} = (h_4 - h_5)/(h_4 - h_{5s}), \dot{W}_{GT} = (\dot{m}_f + \dot{m}_{air})(h_4 - h_5)$
Pump	$\eta_p = \frac{v_{12}(p_{13} - p_{12})}{h_{13} - h_{12}}, \dot{W}_p = \dot{m}_{ORC}(h_{13} - h_{12})$
IHE	$(h_{14} - h_{13}) = (h_{16} - h_{17}), \epsilon_{IHE} = (T_{11} - T_{14})/(T_{16} - T_{13})$
Evaporator	$(\dot{m}_{air} + \dot{m}_f)(h_7 - h_{11}) = \dot{m}_{ORC}(h_{15} - h_{14}), \dot{Q}_E = \dot{m}_{ORC}(h_{15} - h_{14})$
Turbine	$\eta_T = (h_{15} - h_{16})/(h_{15s} - h_{15}), \dot{W}_T = \dot{m}_{ORC}(h_{15} - h_{16})$
Condenser	$\dot{m}_{ORC}(h_{17} - h_{12}) = \dot{m}_{water}(h_{19} - h_{18}), \dot{Q}_{COND} = \dot{m}_{ORC}(h_{17} - h_{12})$

The thermodynamic modelling and analysis was done on the basis of the following assumption:

1. All processes of the cycle are in steady state [6,7].
2. Air compressor and gas turbine are assumed adiabatic [7].
3. Lower heating value of the fuel (methane) is 50000 kJ/kg [7].
4. The principles of ideal gas mixtures are used for air and combustion products [7].
5. The pressure drops at air side and gas side are 5% and 3%, respectively [7].
6. Heat transfer from combustion chamber is 2% of lower heating value of the fuel. Other equipments work with no heat losses [7].
7. Heat recovery steam generator is designed in a single-pressure mode in which the water temperature and pressure at the inlet are 298.15 K and 35 bar, respectively. The HRSG outlet state is saturated vapour [4]
8. The organic working fluid enters the turbine as saturated vapour [4].

The basic input parameters of gas turbine and organic Rankine cycles are provided in Table 2, these includes the parameters which are being changed i.e., turbine inlet temperature as well as compression ratio, and range of variation has been provided according to the previously conducted research.

Table 2: Parameters Used in the Modelling (Source [4])

Parameters	Values
T1(K)	273.15-318.15
P1(bar)	1
\dot{W}_{GT} (MW)	30
T3(K)	850
T4(K)	1520
r_p	10
η_{AC} (%)	90
η_{GT} (%)	80
$\Delta T_{pp,HRSG}$ (K)	25
Te(K)	375
Tc(K)	303.20
$\Delta T_{pp,E}$ (K)	5
$\eta_{T(ORC)}$ (%)	80%
$\eta_{p(ORC)}$ (%)	85%
ϵ (%)	90

4.0 Results and Discussion

After the thermodynamic modelling of the system, validation of the model has been done by comparing the properties of working fluid at each point with the results obtained in [4]. R123 was used as a working fluid due to its lower global warming potential.

This validation is provided in the appendix 1 of the paper. In this paper the performance of the system was studied on the basis of first law of thermodynamics only.

The parametric study was done by varying the surrounding temperature and observing the change in behaviour of output by calculating the overall efficiency, total work output, total work output of ORC, mass flow rate of air and mass of heated water delivered.

The analysis was done with the assumption that the electrical load on the gas power plant is constant and power output of the gas turbine is kept constant at 30MW.

The results obtained are shown in figure 2.

Fig 2 (a): Variation of Overall Efficiency with Increase in Surrounding Temperature

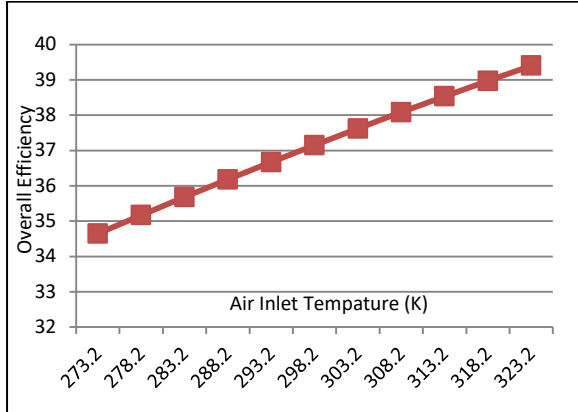

Fig 2 (d): Variation in Steam Output with Change in Surrounding Temperature

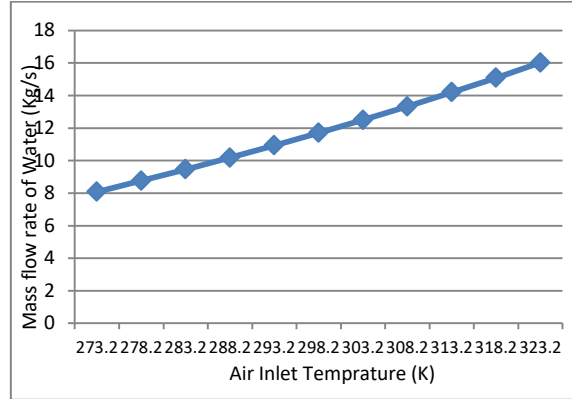

Fig 2 (b): Variation of Work Output with Surrounding Temperature

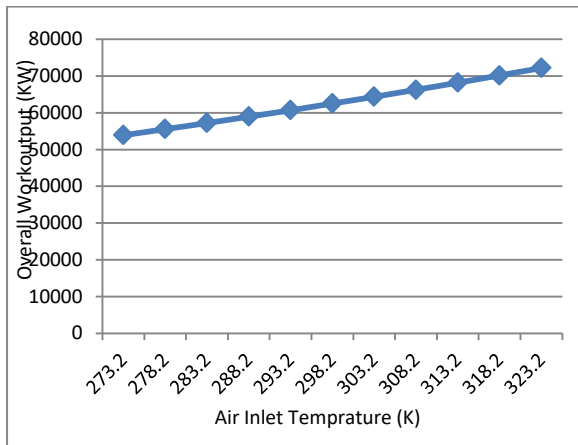

Fig 2 (e): Variation in Work Output of ORC with Change in Surrounding Temperature

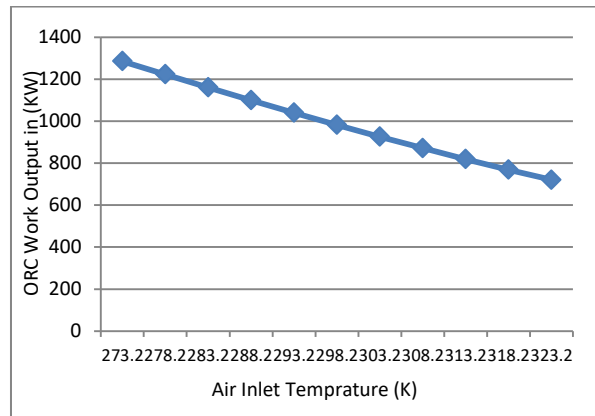
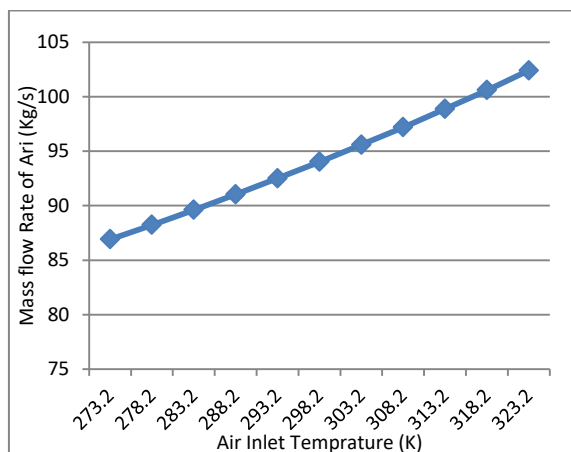

Fig 2 (c): Variation of Mass Flow Rate of Air with Surrounding Temperature



The result obtained shows that with increase in the temperature of inlet air, the overall efficiency of the system increases. This can be attributed to increase in the heated steam recovered at the HRSG which is higher than compared to decrease in the work output at ORC and increase work done at compressor. The overall work output of the system also have similar effect. The mass flow rate of the system increases, with increase in air inlet temperature, as a result of increased work input in compressor with net output and turbine inlet temperature remaining constant. Increased mass flow rate of air increases the mass of steam delivered in HRSG system which have a positive effect on overall efficiency and overall work output. However, with increase in the air inlet temperature the work output of the ORC decreases but since the delivered output is very small in compared to the overall turbine

output its effect is significantly low for the current system. However in case of micro turbine power generation system this can be of eminent importance. The decrease in the output of ORC is attributed to the decreased temperature at outlet of the HRSG system as a result of increased mass flow rate of water with increase in the air inlet temperature. The air at outlet of HRSG act as the heat source for HRSG system. From the results obtained it can be observed that the temperature at the outlet of HRSG varies from 416K to 451K. Thurairaja K. et al., [9] in his work has provided the details of refrigerant that can be used in ORC at the given range of temperature of the heat source. In figure 3 a comparative analysis has been shown between various refrigerant which can be used for a heat source with temperature range of 416-451K in an ORC.

Fig 3: Comparison of Performance of Various Organic Fluid Operating in Bottoming Cycle of Cogeneration System

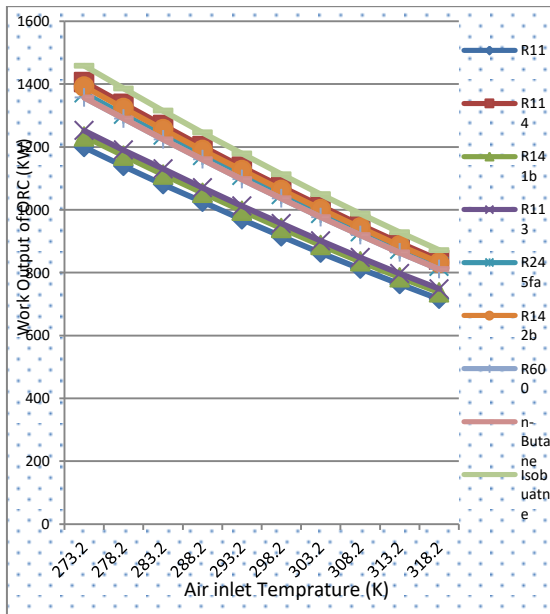

It can be concluded from the above trend that increased surrounding temperature has a adverse effect on ORC work output for any organic working fluid. So it is recommended to increase the heat recovery through ORC in cogeneration system it should be operated in a cold region where air inlet temperature is lower.

Among the various organic fluids used isobutene shows the most promising results. R-114, R-245fa, R-124b and R-600 give near about same

performance. The work output obtained R-11, R-141b, R-113 and n-butane is comparative lower. However the difference is not very significant which makes their environmental impact study a significant part for choice of the organic fluid in the bottoming cycle.

Table 3 provides the point wise comparison of thermodynamic state of fluid under analysis of the given work with the values provided by reference [3] as the result.

Table 3: Comparison of Thermodynamic Properties of Each Stream of GT and ORC in Present Work and Reference [3]

Stream	Working Fluid	T(K) in [3]	T(K)	P(bar) in [3]	P (bar)	ṁ (Kg/s) in [3]	ṁ (Kg/s)
1	Air	298.15	298.15	1.013	1.013	94.75	94.09
2	Air	603.5	603.1	10.13	10.13	94.75	94.09
3	Air	850	850	9.624	9.624	94.75	94.09
4	Combustion gases	1520	1520	9.142	9.142	96.454	95.782
5	Combustion gases	1016	1009	1.157	1.157	96.454	95.782
6	Combustion gases	789.6	743.3	1.122	1.122	96.454	95.782
7	Combustion gases	422.1	413	1.066	1.066	96.454	95.782
8	Water	298.15	298.15	35	35	15.21	13.41
9	Water	515.7	515.7	35	35	15.21	13.41
10	Fuel	298.15	298.15	12	12	1.704	1.692
11	Combustion gases	381.5	371.5	1.013	1.013	96.454	95.684
12	R123	303.2	303.2	1.097	1.097	21.61	24.12
13	R123	303.2	303.5	8.199	8.199	21.61	24.12
14	R123	316.5	316.2	8.199	8.199	21.61	24.12
15	R123	375	375	8.199	8.199	21.61	24.12
16	R123	323.8	323.8	1.097	1.097	21.61	24.12
17	R123	305.5	305.44	1.097	1.097	21.61	24.12

5.0 Conclusions

From the study of the system and its analysis based on the first law of thermodynamics following conclusion can be drawn.

- Increasing the surrounding temperature of the GT-HRSG-ORC integrated system increases mass flow rate of air as well as mass of steam generation.
- Increased mass of steam generation has a positive impact on the overall efficiency of the system which increases with increase in surrounding temperature.
- The work output through ORC decreases as a result of decreased temperature of air at inlet of evaporator.
- The decrease in ORC work output doesn't have a significant effect on the given system. However for micro gas turbine case it can make a significant difference.
- It is recommended to use the system in colder region if the waste heat recover through ORC is required to be enhanced.
- The comparative study between different organic fluid shows isobutene provides with the better result in compared to other organic fluid and is recommended to be used in cogeneration system.

In the present paper the work has been limited to first law analysis only however the second law analysis and cost variation with respect to surrounding condition can further be studied in detail in future and the comparative study between the organic fluid can be studied further with respect to their environmental impact.

Acknowledgment

The authors would like to acknowledge the efforts of the Department of Mechanical Engineering, Delhi Technological University for providing with the necessary resources to carry out the research work and would also like to acknowledge the effort of Institute of Engineers (India), Delhi Centre and IJARI for providing the platform of outlet for this work.

Nomenclature

HRSG	Heat Recovery Steam Generator
------	-------------------------------

GT	Gas Turbine
IHE	Heat Exchanger
CC	Combustion Chamber
ORC	Organic Rankine Cycle
APH	Air Pre Heater
LHV	Lower Heating Value of Fuel
TIT	Turbine Inlet Temperature
η_{AC}	Compressor Efficiency
η_{comb}	Combustion Efficiency
η_{GT}	Turbine Efficiency
ϵ	Effectiveness
rp	Compression Ratio
\dot{W}	Work Output
h	Enthalpy
s	Entropy
∇T_{pp}	Pitch Point Temperature Difference
Q	Heat
m	mass
Subscripts	
p	Pump
T	Turbine
f	Fuel
ac/AC	Air Compressor
gt/GT	Gas Turbine
e	Evaporator
c	Condenser

References

- [1] Cogeneration, Chapter 7, Energy Efficiency in Thermal utilities, Guide Book 2 Bureau of Energy Efficiency, New Delhi, 155-<https://beeindia.gov.in/sites/default/files/2Ch7.pdf>
- [2] BF Tchanche, G Lambrinos, A Frangoudakis, G Papadakis. Low grade heat conversion into power using ORC – A review of various application, Renewable and Sustainable Energy Review, 54(8), 2011, 3963-3979.
- [3] M Khaljani, R Khoshbakti Saray, K Bahlouli. Comprehensive analysis of energy, exergy and exergo-economic of cogeneration of heat and power in combined gas turbine and Organic Rankine cycle, Energy conversion and Management, 97, 2015, 154-165.
- [4] P Ahmadi, I Dincer, MA Rosen. Exergo-environmental analysis of an integrated organic Rankine cycle for trigeneration,

- Energy and Conversion Management , 64, 2012, 447-453.
- [5] M Yari, S Mahmoudi. A thermodynamic study of waste heat recovery from GT-MHR using organic Rankine cycles, Heat and Mass Transfer, 47(2), 2011, 181-196.
- [6] A Bejan. Thermoeconomic optimisation, Thermal design and optimization. G. Tsatsaronis, M Moran, New York USA, A Wiley Interscience publication , 1995, ch. 9, sec. 9.5 1996, 502-506.
- [7] H Ghaebi, M Saidi, P Ahmadi. Exergoeconomic optimization of a trigeneration system for heating, cooling and power production purpose based on TRR method and using evolutionary algorithm. Appl Therm Engineering, 36, 2011, 113-25.
- [8] K Thurairaja, A Wijewardane, S Jaysekara, C Ranasighe. Working fluid selection and performance evaluation of ORC, 5th Tnt. Conf. Power and Energy System Engineering, CPESE, Nagoya, Germany, 9, 2018, 19-21.