

Article Info

Received 02 Feb 2014 | Revised Submission 10 Feb 2014 | Accepted 20 May 2014 | Available Online 15 Mar 2014

**Thermodynamic Performance Evaluation of Alternative Regeneration Gas Turbine
Cogeneration Cycle with Two Shaft System**

P. V. Ram Kumar and S. S. Kachhwaha***

ABSTRACT

This paper presents thermodynamic performance evaluation of gas turbine co-generation with alternative regeneration system in comparison to simple and conventional regenerative cogeneration systems. The energetic and exergetic efficiencies have been defined. The effects of pinch point temperature (PPT) and process steam pressure used in have been investigated. For higher TITs the second law efficiency and power to heat ratio is relatively higher for alternative regeneration with cogeneration system. It is observed from the results obtained that power to heat ratio increases with increase in pinch point but first and second law efficiency decreases with an increase in pinch point. Power to heat ratio increases significantly with increase in process steam pressure but first law efficiency decreases with the same. The second law efficiency increases with increase in process steam pressure up to 1 MPa and afterwards decreases with increase in process steam pressure. Results also show that inclusion of cogeneration with alternate regeneration provides significant improvement in process heat production and second law efficiency.

Keywords Exergetic Analysis; Gas Turbine System; Co-Generation; Power to Heat Ratio; Alternative Regeneration.

1.0 Introduction

The gas turbine applications have been expanded appreciably due to significant improvements in cycle efficiency in the recent years. According to a report of international energy outlook 2004 the world net electricity consumption is expected to nearly double over the next two decades. Therefore it is important to find improved technologies for power generation that have high efficiency and specific work output, low investment, low operating and maintenance cost and low emissions of pollutants.

The advantage of gas turbines lies in the fact that they have high power/weight ratio compared to reciprocating engines. In recent years the observed performance enhancements in the gas turbine technologies can be attributed to the advancements in the fields of aerodynamics, materials and coatings, blade cooling and fabrication technologies. These

technologies have allowed achieving the turbine inlet temperature value of 15000 C and simple cycle efficiencies of 40 % and more. In a simple gas turbine (GT) system, high pressure ratio is required to obtain high thermal efficiency due to the absence of a heat exchanger.

The application of regenerator or heat exchanger has caused significant impact on the gas turbine cycle to obtain higher efficiency at low pressure ratios by utilising the waste heat carried by the exhaust gases.

This waste heat is utilised to preheat the air between compressor and combustion chamber. In this way the average temperature of air at which heat is added during combustion is increased resulting in higher cycle efficiency. Ganesan [1], Cohen et al. [2], Cengel [3] and Nag [4] have suggested the different cycle arrangements to improve efficiency and net work output of the system. Nishida et al. [5] studied the regenerative steam injection gas turbine systems

*Corresponding Author: Department of Mechanical Engineering, Delhi College of Engineering, Delhi, India (E-mail pvrde@rediffmail.com)

**Department of Mechanical Engineering, PDP University, Gandhi Nagar, Gujarat, India

(RSTIG). The performance characteristics of the two regenerative steam injection GT systems (RSTIG-1, RSTIG-2) have been analyzed [1-steam from heat recovery steam generator (HRSG) is directly injected into the combustion chamber (CC) & 2-steam from HRSG is injected after the air compressor] and the variation of thermal efficiency and specific power with operating parameters were investigated. Najjar [6, 7] studied the enhancement of performance of gas turbine engines by inlet air cooling and co-generation system and reported the improvement in power output, efficiency and SFC in the combined system over simple gas turbine cycles and thermo economic evaluation showed that the combined system is viable. It has been found from the literature survey that research work has been carried out in thermodynamic analysis of various conventional gas turbine cycles with reheating, conventional regeneration, steam injection and intercooling. Nowadays inlet air cooling techniques have been an integral part of conventional GT cycles applicable to cogeneration and combined cycles. Khaliq et al. [8] studied the thermodynamic performance evaluation of combustion gas turbine co-generation system with reheat and presented a methodology based on first and second law of thermodynamic analysis and observed that the reheat expansion gives significant improvement in first and second law efficiency and selection of co-generation system is a complex decision involving technical as well as economic considerations.

The inclusion of reheat gives significant improvement in electrical power output, process heat production, fuel utilization (energetic) efficiency and second law (exergetic) efficiency. But the power to heat ratio decreases with reheat because improvement in process heat production is greater than electrical power output. Khaliq et al.[9] studied combined first and second law analysis of gas turbine cogeneration system with inlet air cooling and evaporative after cooling of the compressor discharge and reported the detailed exergy destructions in the combustion chamber, regenerative heat exchanger, reheater and HRSG. Dellenbeck [10] reported that the cycle efficiency of alternative configuration is superior to either a conventional regenerative cycle or a simple cycle. The alternative regeneration system is particularly attractive at high turbine inlet temperatures. For turbine inlet temperatures as high

as 1500 0 C the optimum pressure ratio is only 30 whereas for the same conditions the optimum pressure ratio of a simple cycle is excessive (>40) for temperatures larger than 1115 0 C. Dellenbeck [10] had explained that the location of regenerator after the power turbine is inefficient and suggested that the location of regenerator between two turbines (alternative regenerator configuration) improves the cycle efficiency. Hwang et al. [11] studied the design and off-design characteristics of the Alternative Recuperated Gas Turbine Cycle with divided turbine expansion and their study included the fundamental characteristics, various design options and part load analysis of the cycle and its comparison with conventional cycle. Only with very high component efficiencies, the maximum cycle efficiency of the alternative cycle is higher than that of the conventional cycle. Two shaft design of the alternative cycle requires very high compressor pressure ratio for its efficiency to be comparable with the conventional cycle. On the contrary the single shaft design provides a rather wide range of compressor design pressure ratio. By designing with single shaft configuration and operating with variable shaft speed, the alternative cycle provides far better part load efficiency than conventional cycle.

In this paper Thermodynamic performance analysis of gas turbine co-generation system with alternative regeneration is studied. As the location of alternative regenerator between two stages of turbine is recently introduced concept, it is felt that a complete and thorough detail of thermodynamic energy analysis is to be studied with detailed parametric analysis for wide range parameters. It is seen from the literature survey that alternative regenerator system has not been analyzed as compared to other gas turbine regenerative cycles. Hence in the present research paper the combined first and second law analysis of alternative regenerator with cogeneration system has been performed and compared with simple and conventional regenerative GT cogeneration systems.

2.0 Description of GT Cogeneration Systems

The GT alternative regeneration with cogeneration configuration is shown in Fig 1, which consists of compressor, high pressure turbine, combustion chamber, power turbine and alternate

regenerator which is proposed for thermodynamic analysis. The T-s diagram of alternative regeneration with cogeneration configuration is shown in Fig 4. The atmospheric air is compressed in the compressor and then it enters into alternate regenerator where it is heated by the exhaust gases from high pressure turbine. The preheated air enters into combustion chamber where heat is added to maximum permissible temperature. The hot gases expand and develop the power in the high pressure turbine such that the total work output of this turbine is utilised to run the compressor. The gases coming out from the high pressure turbine passes through alternate regenerator where it exchanges heat to preheat the air and finally expand in power turbine. The power developed by the power turbine is the work output of the system. Hot exhaust from the alternative regenerator is the waste heat source for process heat production. The energy and exergy process heat produced will depend on the temperature of hot exhaust gas entering and the temperature of saturated steam produced in the heat recovery steam generator. Hence it is obvious that the pinch point as well as pressure of process steam will have a significant effect on performance parameters. Fig 2 shows gas turbine cogeneration cycle with regeneration and Fig. 3 shows simple gas turbine cogeneration cycle.

Fig 1: GT Alternative Regeneration with Co-Generation Cycle

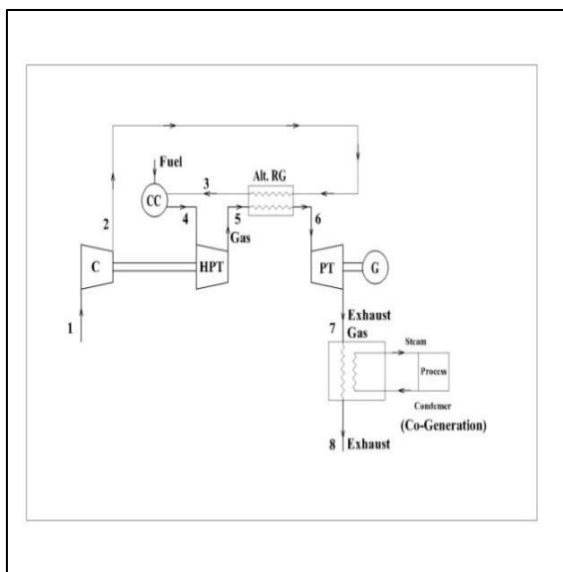

Fig 2: GT Regeneration Cycle with Co-Generation

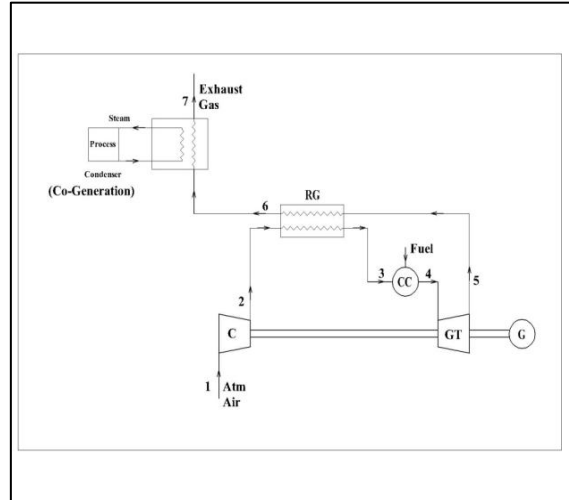

Fig .: GT Simple Cycle with Co-Generation

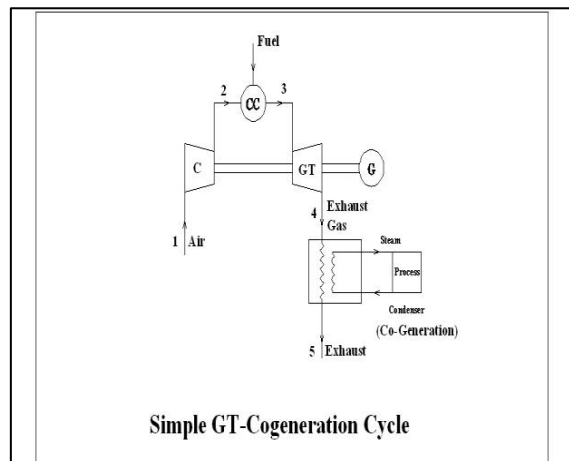
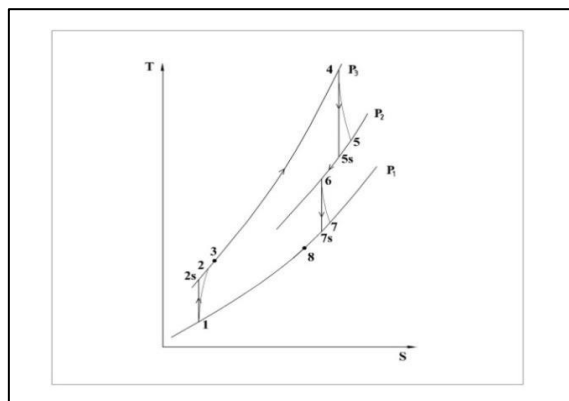

Fig 4: T-s Diagram of GT Alternative Regeneration with Co Generation Cycle



3.0 Thermodynamic Analysis

Thermodynamic formulations for gas turbine cogeneration cycle with alternative regenerator (Fig. 1), gas turbine cogeneration cycle with regeneration (Fig. 2) and simple gas turbine cogeneration cycle (Fig. 3) has been developed and compared for similar input conditions. Fig. 4 represents the corresponding T-s diagram of the alternate regeneration system configuration. For the conventional regeneration the single shaft configuration is considered whereas for the alternate regeneration two shafts configuration is adopted. The air at atmospheric conditions (T1, p1) enters into the compressor. The exit pressure after compression is p2.

The pressure ratio of the compressor is

$$r = \frac{p_2}{p_1} \tag{1}$$

The effectiveness of regenerator is defined as

$$E = \frac{T_3 - T_2}{T_5 - T_2} \tag{2}$$

where T3 and T5 are temperature of air leaving the regenerator and outlet temperature of gas from high pressure turbine (HPT) entering the regenerator respectively.

As per the assumed condition, the high pressure turbine (HPT) is only meant for running the compressor, therefore

$$W_c = W_{HPT} \tag{3}$$

The inlet temperature of hot gases at HPT inlet is T4. After expansion, the exit temperature is given by T5. The temperature ratio for ideal expansion process and efficiency of HPT are given by

$$\frac{T_4}{T_{5s}} = (r_{HPT})^{\frac{\gamma-1}{\gamma}} \tag{4}$$

The temperature of air leaving the regenerator is calculated using equation

$$T_3 = T_2 + E (T_5 - T_2) \tag{5}$$

The heat balance equation in the regenerator is given by

$$C_{pa}(T_3 - T_2) = (1+f) C_{pg}(T_5 - T_6) \tag{6}$$

The temperature ratio for ideal expansion process in power turbine (PT) and efficiency of PT (η_{PT}) are given by

$$\frac{T_6}{T_{7s}} = (r_{PT})^{\frac{\gamma-1}{\gamma}} \tag{7}$$

The specific work output from the power turbine is given by

$$W_{PT} = (1+f) C_{pg}(T_6 - T_7) \tag{8}$$

Where T_7 is the temperature of gas leaving the power turbine.

4.0 Performance Parameters

The relevant parameters for the combined first and second law analysis of alternative regeneration gas turbine cogeneration system may be considered as follows

4.1 First law efficiency

The first law efficiency is defined as the ratio of the energy in the useful products (electricity and process heat) to the energy of the fuel input. By definition,

$$\eta_{I} = \frac{W_{el} + Q_p}{E_f} \tag{9}$$

Where W_{el} is the electrical power output and is given by

$$W_{el} = W_{PT} * \eta_{gen} \tag{10}$$

4.2 Power to heat ratio (RPH)

The parameter used to assess the thermodynamic performance of a cogeneration system is power to heat ratio. The power to heat ratio is defined as ratio of electrical power output to the process heat.

$$R_{PH} = \frac{W_{el}}{Q_p} \tag{11}$$

For both the first law efficiency and power to heat ratio, power and heat are treated as equal. As first law of thermodynamics is concerned with quantity not exergy quality, first law efficiency and power to heat ratio are also known as first law efficiencies.

4.3 Second law efficiency

As the exergy is more valuable than energy according to the second law of thermodynamics, it is always useful to consider both output and input in terms of exergy. The amount of exergy in the products to an amount of exergy supplied is defined as second law efficiency. The second law efficiency is a more accurate measure of the thermodynamic performance of a system. It is given by the equation

$$\eta_{II} = \frac{W_{el} + B_p}{B_f} \quad (12)$$

Where B_p the exergy is content of process heat produced and B_f is the exergy content of fuel input. The second law efficiency or exergetic efficiency is also be given as

$$\eta_{II} = (\eta_I / \xi_f) \left(\frac{R_{PH} + \xi_p}{R_{PH} + 1} \right) \quad (13)$$

Where ξ_p the exergy factor of process is heat and ξ_f is the exergy factor of fuel input.

The exergy factor of process heat is always less than unity and is given as

$$\xi_p = \frac{B_p}{Q_p} \quad (14)$$

The exergy factor of fuel input is given as

$$\xi_f = \frac{B_f}{E_f} \quad (15)$$

The exergy factor of fuel input is close to unity for most fuels as chemical energy in fuel is essentially all exergy.

From first law of thermodynamics, the process heat produced may be given as

$$Q_p = m_s (h_g - h_c) \quad (16)$$

By applying the heat balance equation in heat recovery steam generator (HRSG), we may have

$$m_s (h_g - h_f) = m_a (1 + f) (h_7 - h_{pp}) \quad (17)$$

The steam flow rate is given as

$$m_s = m_a (1 + f) (h_7 - h_{pp}) / (h_g - h_f) \quad (18)$$

Hence the process heat produced per unit mass of air flow is given as

$$\frac{Q_p}{m_a} = (1 + f) (h_7 - h_{pp}) (h_g - h_c) / (h_g - h_f) \quad (19)$$

From second law of thermodynamics, the exergy content of process heat is given as

$$B_p = m_s [(h_g - h_c) - T_o (S_g - S_c)] \quad (20)$$

Table 1: Characteristics for Analysis

Ambient conditions	101.3 kPa and 300 K
The pressure loss in combustion chamber	3 %
The pressure loss in regenerator	2 %
Compressor efficiency	86 %
Turbine efficiency	89 %
Combustor efficiency	99 %
ξ_f	1
Condensate temperature (T_c)	373 K

The important operating parameters for thermodynamic performance analysis are pressure ratio (r), turbine inlet temperature (TIT), process steam pressure and the pinch point temperature (PPT). The effect of variation of these parameters on first law efficiency, second law efficiency and power to heat ratio has been studied in detail. The range for the variation of these parameters is discussed below.

5.0 Results and Discussion

The thermodynamic performance of the gas turbine alternative regeneration with cogeneration system is analysed and compared with conventional regeneration and simple gas turbine cycles for wide range of design parameters. The process steam pressure is varied between 0.5 and 3.5 MPa at TIT of 1500 0C and the pressure ratio is varied up to 40 for TIT of 1500 0C for the corresponding optimum pressure ratios of the above cycles. The comparison for the variation of cycle efficiency with pressure ratio for alternative regeneration, conventional regeneration and simple cycle is shown in Fig. 5. For The maximum cycle efficiency the corresponding optimum pressure ratios obtained are 22.5, 8.5 and 40 respectively for the alternative regeneration, conventional regeneration and simple cycle systems.

The pinch point temperature (PPT) is varied between 10 and 50 oC. The Table 1 shows various inputs required for during parametric analysis. The effect of variation of these parameters on first law efficiency, second law efficiency and power to heat

ratio has been studied in detail and compared with conventional regeneration and simple GT cogeneration systems. These values are approachable in the recently developed components of gas turbine cycles.

5.1 Effect of pressure ratio

The effect of pressure ratio on system performance is shown in Figs 6-8 with process steam pressure of 1 MPa, PPT of 30 oC and TIT of 1500 0C. It is observed that first law efficiency of alternative regeneration with cogeneration decreases till its optimum pressure ratio and after that the difference in decrease in first law efficiency of GT alternative regeneration with cogeneration is quite significantly small. It is observed that first law efficiency of conventional regeneration with cogeneration decreases till its optimum pressure ratio and after that it increases. The second law efficiency increases up to its optimum pressure ratio after that it decreases due to reduced process heat produced at higher pressure ratio. The difference in decrease in second law efficiency of GT alternative regeneration with cogeneration is quite significantly small compared to conventional regeneration with cogeneration. The power to heat ratio increases up to optimum pressure ratio and afterwards decreases with increase in pressure ratio for both alternative and conventional regeneration GT cycles with cogeneration. Because the increase in pressure ratio increases the compressor work and results in less net work output at higher pressure ratios. The first law efficiency, second law efficiency and the power to heat ratio of simple cycle GT cogeneration cycle increases with increase in pressure ratio.

5.2 Effect of turbine inlet temperature

The effect of turbine inlet temperature (TIT) on system performance is shown in the Figs 9-11 with process steam pressure of 1 MPa, PPT of 30 oC and the corresponding optimum pressure ratios of GT systems. It is observed that the first law efficiency increases with increase in TIT whereas the first law efficiency of alternative regeneration with cogeneration system is lower as compared to conventional regeneration because of lesser process heat available in the alternative regeneration cycle. But the second law efficiency quite significantly increases with increase in TIT and the second law

efficiency of alternative regeneration with cogeneration is higher than other two GT cycles at TITs 1300 0C and above. With this second law analysis, it is observed that alternative regeneration with cogeneration system is more suitable at higher TITs as compared to lower TITs. Power to heat ratio increases with increase in TIT as it is expected and it is higher for alternative regeneration GT cogeneration system as compared to other two GT cycles.

5.3 Effect of process steam pressure

The Figs 12-14 show the effect of process steam pressure on system performance at a PPT of 30 oC. The first law efficiency decreases with increase in process steam pressure for all three system configurations. The decrease in first law efficiency is quite large in case of alternative regeneration GT cogeneration compared to other two cycles because of less process heat production and less work output at larger process steam pressures. The second law efficiency increases quite significantly for conventional regeneration / simple GT cogeneration cycle whereas second law efficiency of alternative regeneration with cogeneration increases up to 1 MPa and after that it decreases with larger process steam pressures. Because at larger process steam pressures, it results in higher flue gas temperature which again results in less process heat associated with exergy destruction. The power to heat ratio increases with increase in process steam pressure because of less process heat available at larger pressures of process steam. The power to heat ratio for alternative regeneration GT cogeneration is higher than the other two GT cogeneration cycles because relatively less process heat is produced in the alternative regeneration GT cogeneration cycle.

5.4 Effect of pinch point temperature

The effect of pinch point on system performance is shown in Figs 15-17 with process steam pressure of 1 MPa. It is observed that the first law efficiency decreases with increase in the pinch point temperature (PPT) and the first law efficiency of alternative regeneration with cogeneration is less than the conventional regeneration and simple GT cycles. The second law efficiency which is a more accurate measure of thermodynamic performance decreases with larger pinch point. The rate of decrease in second law efficiency is smaller than the

rate of decrease in first law efficiency because exergy of the process heat will be less than energy process. The first law efficiency of conventional regenerative system with cogeneration is higher for entire range of PPT as compared to alternative regeneration with cogeneration and vice-versa for second law efficiency. At larger pinch points, exergy destruction is larger for conventional regeneration / simple GT cogeneration cycle compared to alternative regeneration GT cogeneration cycle. The power to heat ratio increases with an increase in pinch point because a higher pinch point will result in a higher temperature in flue gas, hence less process heat will be produced for larger pinch point temperatures.

Fig 5: Effect of Pressure Ratio on Cycle Efficiency with TIT 1500 0C

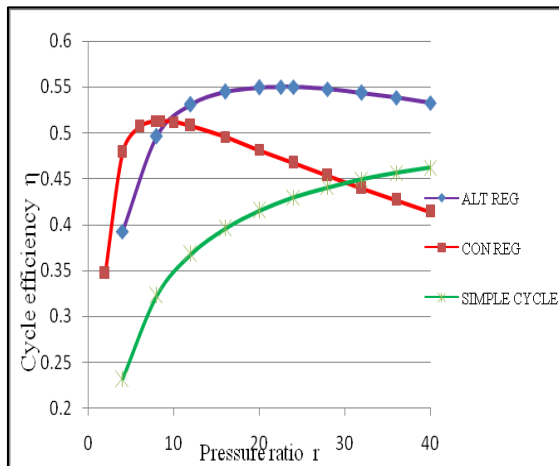

Fig 6: Effect of Pressure Ratio on First Law Efficiency

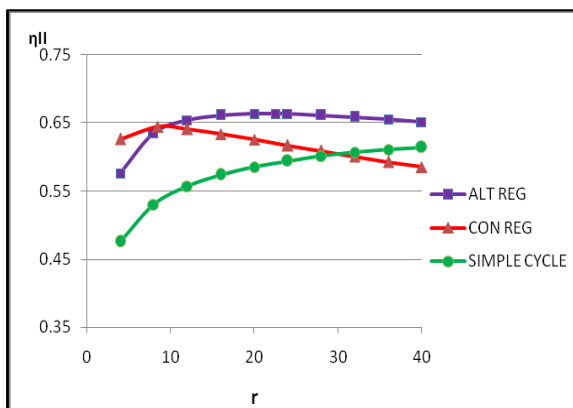

Fig 7: Effect of Pressure Ratio on Second Law Efficiency

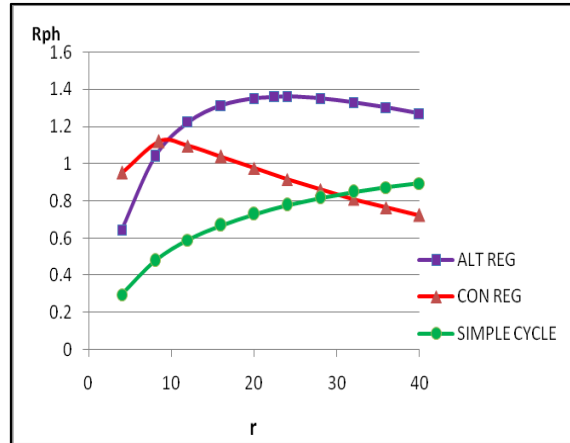

Fig 8: Effect of Pressure Ratio on Power to Heat Ratio

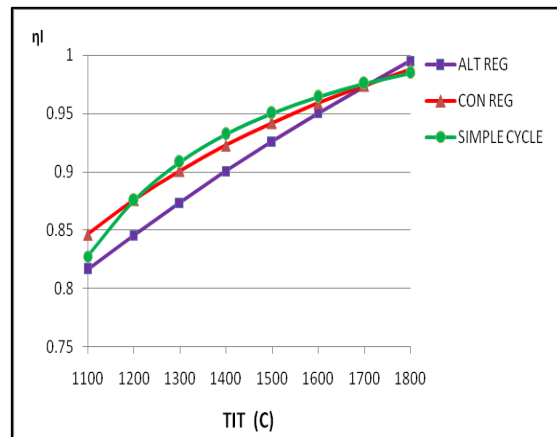

Fig 9: Effect of TIT on First Law Efficiency

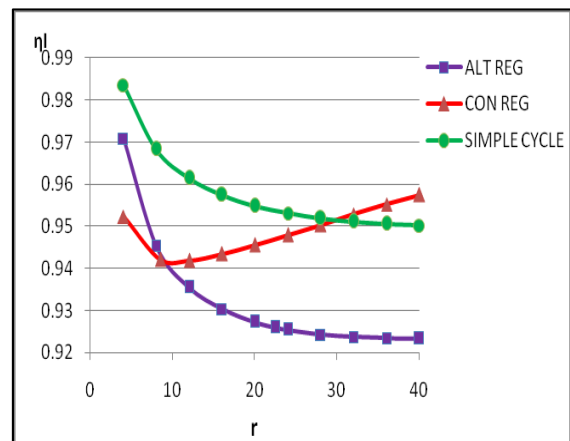

Fig 10: Effect of TIT on Second Law Efficiency

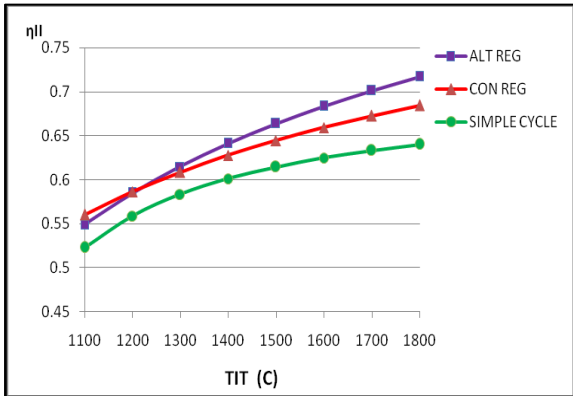

Fig 11: Effect of TIT on Power to Heat Ratio

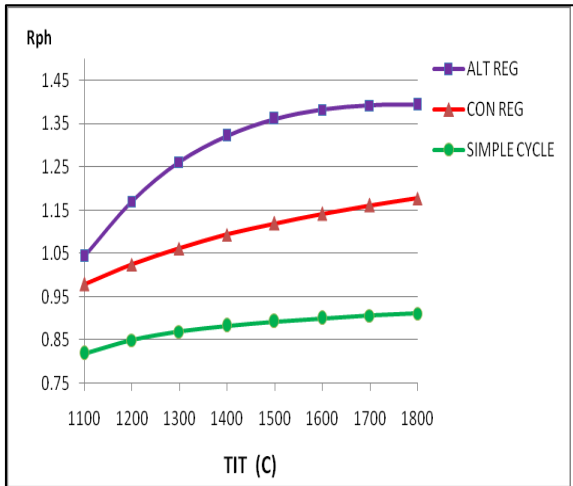

Fig 12: Effect of Process Steam Pressure on First Law Efficiency

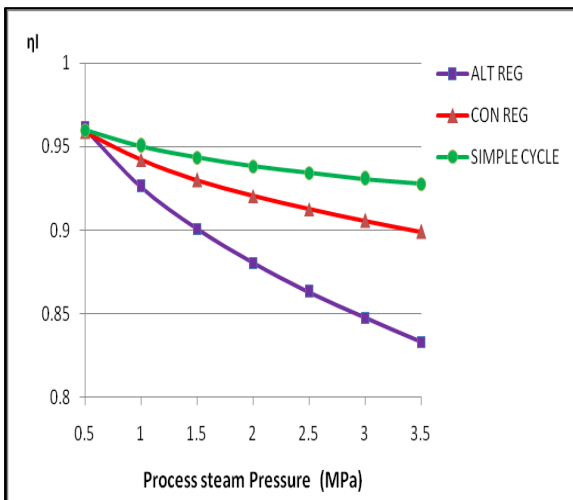

Fig 13: Effect of Process Steam Pressure on Second Law Efficiency

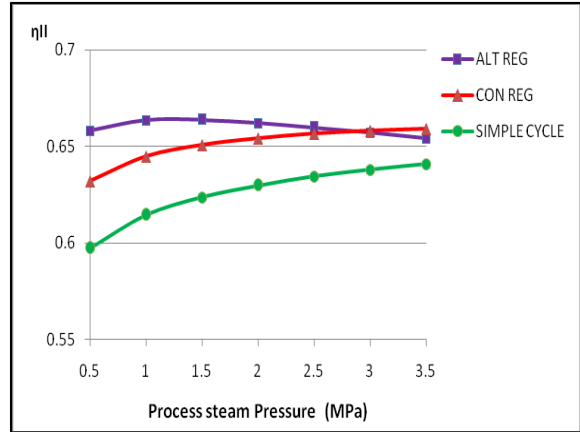

Fig 14: Effect of Process Steam Pressure on Power to Heat Ratio

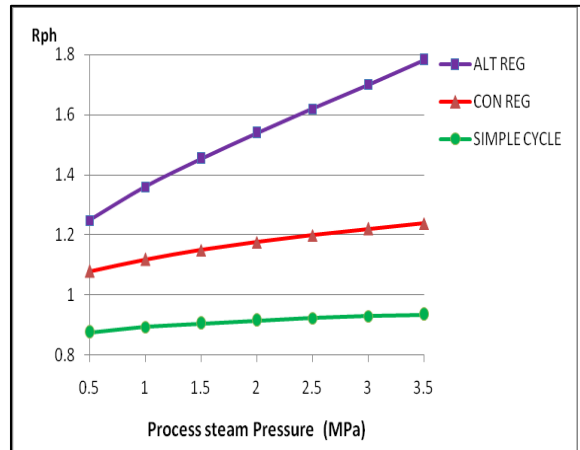

Fig 15: Effect of PPT on First Law Efficiency

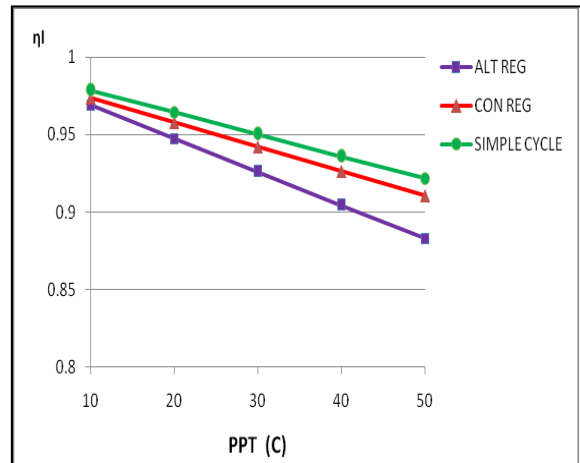

Fig 16: Effect of PPT on Second Law Efficiency

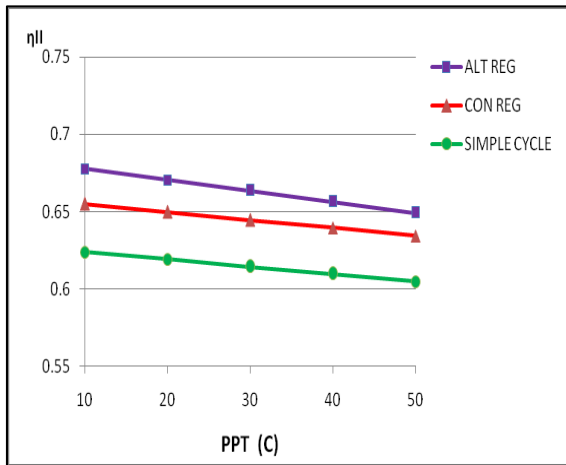
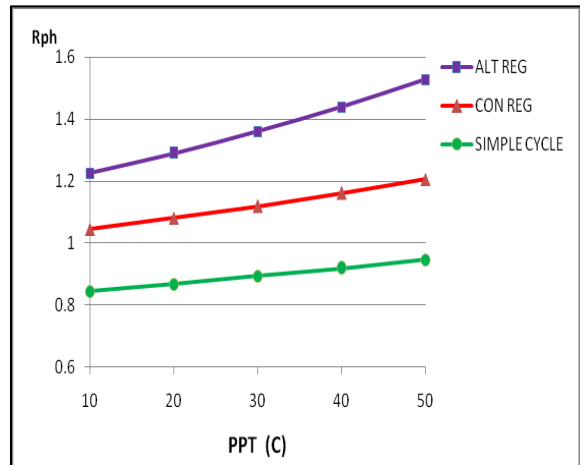

Fig 17: Effect of PPT on Power to Heat Ratio



6.0 Conclusions

A first and second law thermodynamic performance analysis of gas turbine cogeneration system with alternative regeneration has been presented and compared with conventional regeneration and simple GT cogeneration systems. As the performance analysis of gas turbine cogeneration system based on first law alone is not sufficient, second law analysis has been included. Gas turbine cogeneration system with alternative regeneration gives significant improvement in second law efficiency at higher TITs, lower PPTs and lower process steam pressures respectively.

References

[1] V. Ganesan, Gas Turbines by Tata Mc Graw Hill Publications

[2] Cohen et al., Gas turbine theory by Pearson Education Publications

[3] Y Cengel, Thermodynamics – An engineering approach by Mc Graw Hill Publications

[4] P. K. Nag, Power Plant Engineering by Tata Mc Graw Hill Publications

[5] Kousuke Nishida et al., Regenerative steam injection gas turbine systems – Applied Energy 81, 2005, 231-246

[6] Y. S. Najjar , Enhancement of performance of gas turbine engines by inlet air cooling and co-generation system – Applied Thermal Engineering 16(2), 163-173, 1996

[7] Y. S. Najjar et al., Augmentation of gas turbine performance using air coolers – Applied Thermal Engineering (24) 2004, 415-429

[8] Khaliq et al., Thermodynamic performance evaluation of combustion gas turbine cogeneration system with reheat, Applied Thermal Engineering (24) 2004

[9] Khaliq et al., Combined first and second law analysis of gas turbine cogeneration system with inlet air cooling and evaporative after cooling of the compressor discharge ASME Journal for Gas Turbine and Power, 129, 2007

[10] P. A. Dellenbeck, Improved gas turbine efficiency through alternative regenerative configuration, ASME Journal for Gas Turbine and Power, 2002, 124

[11] Sung Hoon Hwang et al., Design and off-Design characteristics of the Alternative Recuperated Gas Turbine Cycle with divided turbine expansion - ASME Journal for Gas Turbine and Power, 2007, 129

Nomenclature

CV	calorific value of fuel in kJ/kg
f	fuel flow rate per unit air flow rate in kg of fuel/ kg of air
T1	inlet air temperature in K
TIT	turbine inlet temperature in K
Δp	pressure drop in bar
r	compressor pressure ratio
Cp	specific heat in kJ/kg/K
Qp	process heat in kJ/s
Wel	electrical power output in kW
Bp	exergy content of process heat in kJ/s
Bf	exergy content of fuel input in kJ/s
PPT	pinch point temperature in K
h	enthalpy in kJ/kg
S	entropy in kJ/kg/K

Greek symbols

E	effectiveness of regenerator
η	thermal efficiency of cycle
ν	ratio of specific heat exergy factor

Subscripts

a	ambient air
g	gas
c	condensate
C	compressor
cc	combustion chamber
f	fluid
HPT	high pressure turbine
PT	power turbine