

**Article Info**

Received: 10 Oct 2014 | Revised Submission: 25 Oct 2014 | Accepted: 20 Nov 2014 | Available Online: 15 Dec 2014

---

**Thermodynamic Irreversibilities Analysis of Industrial Ice Plant**

*R. S. Mishra\* and S. S. Kachhwaha\*\**

---

**ABSTRACT**

*The behavior of single-stage vapour compression-refrigeration cycle, using NH<sub>3</sub>, has been investigated by the exergy method. The condenser and the evaporator's saturation temperatures were varied from 295 K to 305 K and from 249 K to 239 K respectively. The effects of temperature changes in the condenser and evaporator on the plant's irreversibility rate were determined. The greater the temperature difference between either (i) the condenser and the environment, or (ii) the evaporator and the cold room, the higher the irreversibility rate. Reduction in the irreversibility rate of the condenser gives approximately 2.58 times greater reduction in the irreversibility rate for the whole plant, whereas reduction in the evaporator's irreversibility rate gives a 2.32 times greater mean reduction in the irreversibility rate of the whole plant. Because the changes in the temperatures in the condenser and the evaporator contribute significantly to the plant's overall irreversibility, there is considerable scope for optimizing the condition imposed upon the condenser and evaporator.*

**Keywords:** *Energy and Exergy Analysis; Efficiency Defect; Vapour Compression Refrigeration System; Ice Plant.*

---

**1.0 Introduction**

Thermodynamic processes in refrigeration system releases large amount of heat to the environment. Further, heat transfer between the system and the surrounding environment takes place at a finite temperature difference, which is a major source of irreversibility for the cycle and also responsible for the system performance degradation. The losses in the cycle need to be evaluated considering respective individual thermodynamic processes by applying first and second laws. Energy analysis (First Law) is still the most commonly used method in the analysis of thermal systems which only concern with the conservation of energy, and gives no information on how, where, and how much the system performance is degraded. On the other hand, second law is used to describe the quality of energy of materials.

The first law optimization results in maximizing the coefficient of performance (COP) thus providing maximum heat removal from minimum power input; while the second law optimization is used for maximizing the exergy efficiency and minimizing entropy generation within

the system, hence providing maximum cooling for the smallest distraction of available energy (exergy).

The exergy method, known as the second law analysis calculates the exergy loss caused by irreversibility which is an important thermodynamic property that measures the useful work that can be produced by a substance or the amount of work needed to complete a process. Thus exergy analysis is powerful tool in the design, optimization, and performance evaluation of energy systems.

The principles and methodologies of exergy analysis are well established [1-4]. An exergy analysis is usually aimed to determine the maximum performance of the system and identify the sites of exergy destruction. Exergy analysis of a complex system can be performed by analyzing the components of the system separately. Identifying the main sites of exergy destruction shows the direction for potential improvements. An important objective of exergy analysis for system that consume work such as refrigeration, liquefaction of gases, and distillation of water is to find the minimum work required for a certain desired result [5].

There are several studies on the exergy analysis of refrigeration system [6, 7]. Bejan [7]

---

\*Corresponding Author: Department of Mechanical Engineering, Delhi Technological University, New Delhi, India  
(E-mail: professor\_rsmishra@yahoo.co.in)

\*\*Department of Mechanical Engineering, Delhi Technological University, New Delhi, India

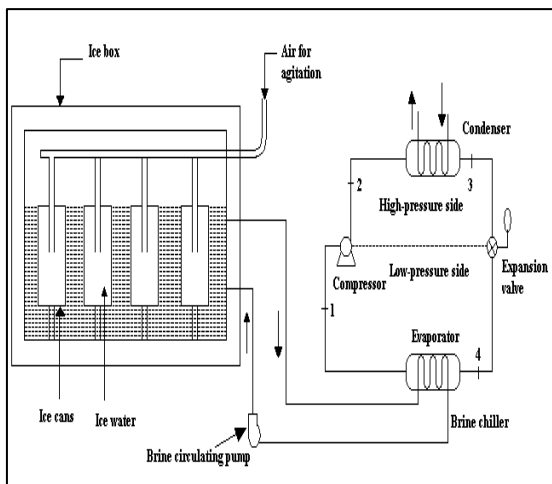
showed that the exergetic efficiency decreases as the refrigeration temperature decreases. He offered two simple models to explain this trend. In his model, thermodynamic imperfections are explained largely by the heat transfer irreversibility. The behaviour of two stage compound-cycle with flash intercooling, using refrigerant R22 has been investigated by Nikolaidis and Probert [8] using exergy method. A computational model based on the exergy analysis is presented by Yumrutas et. al [9] for the investigation of the effects of the evaporating and condensing temperatures on the pressure losses, exergy losses, second law of efficiency, and the COP of a vapour compression cycle.

In the present research work, exergy analysis is performed on the operating data of vapour compression refrigeration cycle of an industrial ice plant. The expressions for the exergy losses (lost works) for the individual processes of the cycle as well as the coefficient of performance (COP) and second law efficiency for the entire cycle has been obtained. Effect of variation of condensing and evaporating temperatures on exergy losses, second law efficiency and COP has been investigated. The concept of structure coefficient (coefficient of structure bond) is used to explain the relation between irreversibilities of system & its component.

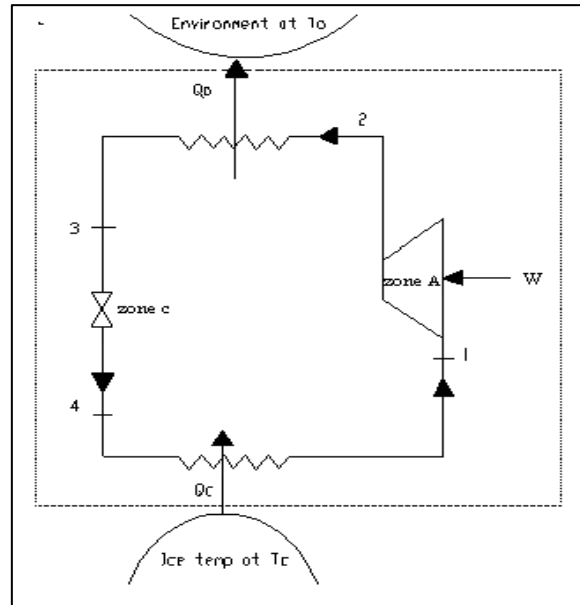
**2.0 Plant Description and Thermodynamic Formulation**

As shown schematically in Figure 1,

**Fig: 1a. Schematic Diagram of an Industrial Ice Plant**

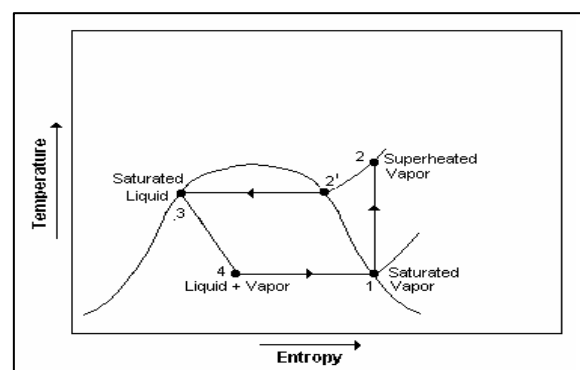


**Fig: 1a. Schematic Diagram of an Industrial Ice Plant**



The main components of an industrial ice plant are compressor, expansion valve, condenser and evaporator (brine chiller connected with ice box). Ice tank is made of mild steel plates and having heavy insulation of granulated corks around 300 mm in thickness. The tank is filled with recirculated brine in which cans filled with water are immersed. The tank is provided with piping for blowing air into ice cans to create agitation. In the present industrial ice plant, single stage vapour compression system has been used for ice production. Reverse osmosis water is being used in the plant for production of ice cubes. The corresponding temperature versus entropy diagram for this system is given in Figure 2.

**Fig: 2. T-s Diagram of Single Stage Vapour Compression Cycle**



At point 1, the circulating refrigerant enters the compressor as a saturated vapour. From point 1 to point 2, the refrigerant vapour is isentropically compressed and exits the compressor as a superheated vapour. From point 2 to point 2', the superheated vapour travels through part of the condenser which removes the superheat by cooling the vapour. Between point 2' and point 3, the vapour travels through the remainder of the condenser and is condensed into a saturated liquid. The condensation process occurs essentially at constant pressure. Between points 3 and 4, the saturated liquid refrigerant passes through the expansion valve and undergoes an abrupt decrease of pressure. This process results in the adiabatic flash evaporation and causes auto-refrigeration of a portion of the liquid refrigerant (typically, less than half of the liquid flashes). The adiabatic flash evaporation process is isenthalpic (i.e., occurs at constant enthalpy) in nature. Between points 4 and 1, the cold and partially vaporized refrigerant travels through the coil or tubes in the evaporator where it is totally vaporized by the warm water (from the space being refrigerated) that circulates across the coil or tubes in the evaporator. The evaporator operates at essentially constant pressure.

The resulting saturated refrigerant vapor returns to the compressor inlet at point 1 to complete the thermodynamic cycle. The various data obtained from the 20 Ton capacity industrial ice plant are as shown in table-1

**Table: 1. Data for Single Stage Vapour Compression Industrial Ice Plant**

Observation	Data
Refrigerant	NH <sub>3</sub>
Cooling load	20 T
Saturated vapour evaporating temperature	-24 °C
Saturated vapour condensing temperature	22 °C
Ambient temperature	17 °C
Temperature of ice	-5 °C
Brine water temperature	-10 °C
<b>Reciprocating compressor efficiencies</b>	
Isentropic efficiency	0.73
Mechanical efficiency	0.80
Electrical efficiency	0.90

It should be noted that the above discussion is based on the ideal vapor-compression refrigeration cycle which does not take into account the frictional pressure drop and heat loss in the system, slight internal irreversibility during the compression of the refrigerant vapour, or non-ideal gas behaviour (if any).

### 3.0 Irreversibility Analysis of Ice Plant

To facilitate the thermodynamic analysis, simplified schematic of the present single stage vapour compression industrial plant with control volume is shown in Figure 3, where Q<sub>0</sub> is the heat rejection rate from the condenser, Q<sub>c</sub> is the heat input rate (cooling load) to the evaporator and W is the work input required to the compressor. For the thermodynamic analysis of the industrial ice plant working on vapour compression system (shown in Figure 3), the principles of mass conservation, first and second laws of thermodynamics are applied to each component of the system. Each component can be treated as control volume with inlet and outlet streams, heat transfer and work interactions. For the system, the mass conservation is governed by following equation:

$$\sum m_i - \sum m_o = 0 \quad (1)$$

Where m is the mass flow rate and suffix i and o represents inlet and outlet of the component.

The first law of thermodynamics yields the energy balance of each component of the system as follows:

$$\sum (mh)_i - \sum (mh)_o + [\sum Q_i - \sum Q_o] + W = 0 \quad (2)$$

The overall energy balance of the system requires that the sum of the evaporator, condenser and compressor must be zero. The vapour compression system is assumed to be in steady state condition and further if the pump work for brine solution circulation and the environmental heat losses are neglected, the energy balance for the entire system can be written as

$$Q_0 = Q_c + W \quad (3)$$

The energy balance equations of various components of a vapour compression system are given below:

Mass flow rate of circulated refrigerant can be calculated as

$$m_R = Q_c / (h_1 - h_4) \tag{4}$$

For the compressor (by convention, the work done by compressor is presumed to be negative);

$$W_c = - m_R (h_2 - h_1) / \eta_m \eta_e \tag{5}$$

Where  $\eta_m$  and  $\eta_e$  are mechanical and electric motor efficiencies respectively

Heat transfer rate in the condenser (zone B) is given by

$$Q_0 = m_R (h_3 - h_2) \tag{6}$$

Coefficient of performance of refrigeration is

$$COP = Q_c / W \tag{7}$$

For state point 4 dryness fraction and specific entropy can be represented as:

$$x_4 = (h_3 - h_f) / (h_1 - h_f) \tag{8}$$

Where  $h_f$  is the enthalpy of saturated liquid refrigerant at evaporator pressure

Specific entropy is:

$$s_4 = s_f + x_4 (s_1 - s_f) \tag{9}$$

Where  $s_f$  is the entropy of saturated liquid refrigerant at evaporator pressure.

Second law analysis is a relatively new concept, which has been used for understanding the irreversible nature of real thermal processes and defining the maximum available energy. The second law analysis is based on the concept of exergy, which can be defined as a measure of work potential or quality of different forms of available energy relative to the environmental conditions. In other words, exergy can be defined as the maximum theoretical work derivable by the interaction for an energy resource with the environment.

Exergy analysis is applied to a system describes loses both in the components of the system and for the system as a whole. With the help of

$$E_Q^D = Q_c (T_0 - T_c) / T_c \tag{16}$$

The exergy rate balance for the condenser, (zone B) is given by

$$I_B = E_2 - E_3 \tag{17}$$

exergy analysis the magnitude of these losses or irreversibility's and their order of importance can be understood respectively. With the use of irreversibility, which is a measure of process imperfection, the optimum operating conditions can be easily determined. It is possible to say that exergy analysis throw an insight to indicate the possibilities of thermodynamic improvement for the process under consideration. The formulation for exergy analysis is described below:

The difference of the flow availability of a stream and that of the same stream at its restricted dead state is called flow exergy ( $\epsilon$ ) and by ignoring chemical exergy terms, flow exergy ( $\epsilon$ ) is given by

$$\epsilon = (h - T_0 s) + V^2/2 + gZ - (h_0 - T_0 s_0) \tag{10}$$

Ignoring the potential and kinematic energy terms, Eq. (10) becomes

$$\epsilon = (h - T_0 s) - (h_0 - T_0 s_0) \tag{11}$$

The exergy balance equation is given by

$$E_w = \sum E_Q + \sum (m\epsilon)_i - \sum (m\epsilon)_o + T_0 S_{gen} \tag{12}$$

In equation (12) the term  $T_0 S_{gen}$  is defined as the irreversibility (I) and can be written as:

$$I = T_0 S_{gen} \tag{13}$$

The above exergy analysis formulation has been performed on each component of the vapour compression system shown in Figure 3, and corresponding irreversibility of each component is calculated. Using this formulation described below:

By carrying out an exergy-rate balance for the compressor, the irreversibility rate (zone A):

$$I_A = W + E_1 - E_2 \tag{14}$$

The exergy-rate balance for the evaporator (zone D):

$$I_D = E_4 - E_1 - E_Q^D \tag{15}$$

Where, for the evaporator

The exergy-rate balance in the throttling valve, (zone C) is given by

$$I_C = E_3 - E_4 \tag{18}$$

Efficiency defect ( $\epsilon_k$ ) of kth component of the system may be expressed as fractions of input which are lost through irreversibility

$$\delta_k = I_k/W \quad (19)$$

Where  $I_k$  is the irreversibility rate of the  $k$ th component of the system under consideration

The total irreversibilities of the system components is expressed as

$$I_t = I_A + I_B + I_C + I_D \quad (20)$$

The relative irreversibility of the  $k^{\text{th}}$  component of plant is

$$= I_k/I_t \quad (21)$$

Structural coefficients are used in the study of the system structure, optimization of plant components and product pricing in multi-product plants. The change of local irreversibility rates and exergy fluxes in relation to the overall plant's irreversibility rate is effectively expressed by the coefficient of structural bonds (CSB) which is defined by

$$\sigma_{k,i} = [\partial I_k / \partial x_i] / [I_k / x_i] \quad (22)$$

Where  $x_i$  is the  $i$ th parameter of the system which produces the changes in  $k$ th component. The effect of a change in  $x_i$  on the system would be to alter the rate of exergy input while leaving the output constant. This acceptance confirms to the usual practice of specifying a plant in terms of its output rather than its input. From the exergy balance of the system

$$E_{IN} = E_{OUT} + I_t \quad (23)$$

But  $E_{OUT} = \text{constant}$ , thus

$$\Delta E_{IN} = \Delta I_t \quad (24)$$

As seen from equation (24) changes in the irreversibility of the system are equivalent to changes in the exergy input. In general, the ratio of the rates of exergy output to exergy input is less than unity. This ratio denotes the degree of thermodynamic perfection of the process and is called the rational efficiency ( $\eta_R$ ).

$$\eta_R = E_{OUT}/E_{IN} \quad (25)$$

Plant rational efficiency

$$\eta_{R, \text{plant}} = 1 - \sum \delta_k \quad (26)$$

#### 4.0 Result and Discussions

Based on the operating plant data shown in Table 1, enthalpy, entropy and exergy at different state points are determined using REFPROP (Table-2)

**Table: 2. Thermodynamic properties at state points**

State	Temperature (K)	Pressure (bar)	Enthalpy (kJ/kg)	Entropy (kJ/kg K)	Exergy (kJ)
1	249	1.57	1.575	6.4407	88.35
2	410.98	9.09	1.827	6.4407	105.85
2'	295	9.09	1.624	5.8266	102.74
3	295	9.09	0.445	1.8301	101.47
4	249	1.57	0.445	1.9055	100.09

**Table: 3. Efficiency defects expressed as percentage for various values of condenser temperatures for a given evaporator temperature = 249 K**

Component	305	303	301	299	297	295
Evaporator	15.25	15.95	16.71	17.53	18.42	19.38
Condenser	9.55	8.7	7.75	6.69	5.50	4.15
Compressor	41.39	41.58	41.78	41.98	42.19	42.4
Throttle valve	5.45	5.27	5.08	4.9	4.72	4.54
Sum	71.64	71.5	71.32	71.1	70.82	70.48
$\eta_R$	28.36	28.5	28.68	28.9	29.18	29.52

**Table: 4. Efficiency defects expressed as percentage for various values of evaporator temperatures for a given condenser temperature = 295 K**

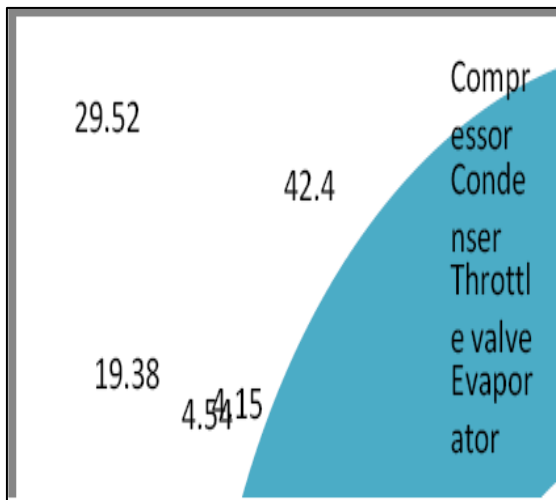
Component	EVAPORATOR TEMPERATURE (K)					
	249	247	245	243	241	239
Evaporator	19.38	20.34	21.18	21.92	22.57	23.14
Condenser	4.15	3.92	3.71	3.51	3.33	3.16
Compressor	42.4	42.18	41.96	41.74	41.52	41.3
Throttle valve	4.54	4.69	4.84	4.99	5.14	5.29
Sum	70.48	71.13	71.69	72.17	72.56	72.89
$\eta_R$	29.52	28.87	28.31	27.83	27.44	27.11



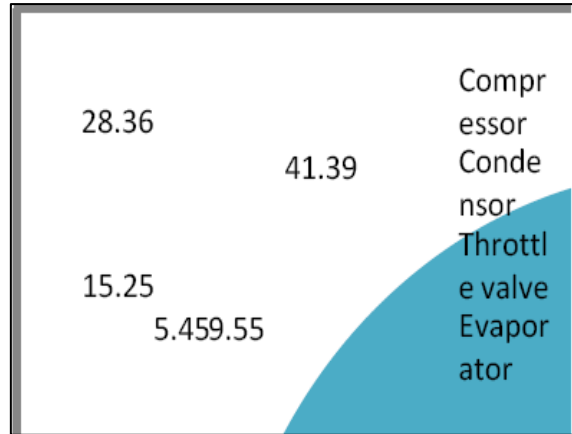
In the present study the condenser and evaporator temperatures are varied between 295 K to 305 K, and 249 K to 239 K, respectively with an interval of 2 K. Table 3 and 4 represents the efficiency defects in percentages for various values of condenser and evaporator temperatures respectively.

As shown in Table 3, when the condenser temperature is varied from 295 K to 305 K, the total efficiency defect in the system increases from 70.48 % to 71.64 %. Whereas the plant's rational efficiency decreases from 29.52 % to 28.36 %. The order of efficiency defects (maximum to minimum) in system components are compressor, evaporator, condenser and throttle valve at 295 K. The efficiency defects in condenser and throttle valve increases with condenser temperature whereas for evaporator and compressor, efficiency defects decreases with increase in condenser temperature. As shown in Table 4, when the evaporator temperature is varied from 249 K to 239 K, the total efficiency defect in the system increases from 70.48 % to 72.89 % whereas the plant's rational efficiency decreases from 29.52 % to 27.16 %. The order of efficiency defects (maximum to minimum) in system components are compressor, evaporator, throttle valve and condenser for all evaporator temperature. The efficiency defects in evaporator and throttle valve increases with decrease in evaporator temperature whereas for condenser and compressor, efficiency defects decreases with decrease in evaporator temperature.

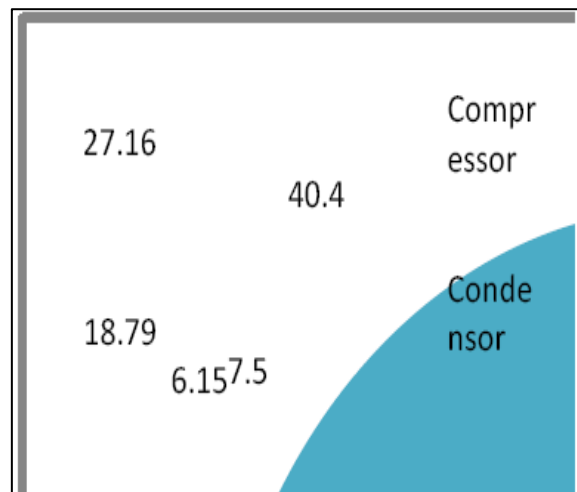
**Fig. 3. Control volume representation of the single stage vapour compression system of industrial ice plant**



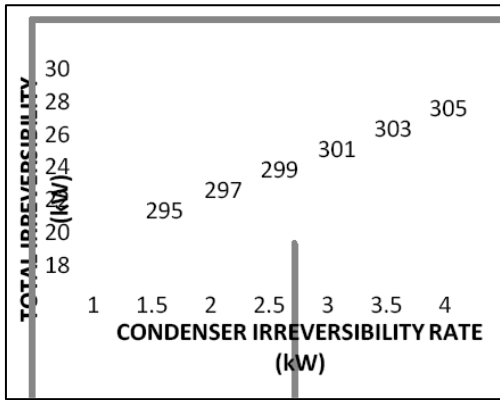
**Fig. 4. Pie chart of efficiency defects for a condenser temperature of 295 K**



**Fig. 5. Pie chart of efficiency defects for Tevap=239 and Tcond=305 K Slope of the line = 2.58**



The three pie charts of Figures 4-6 each show percentages of the input that are lost through irreversibility's in four zones of the plant. There is a direct relationship between the plant's component irreversibility's and their effects on the plant's rational efficiency. The fraction representing the proportion of the input lost through irreversibility's in the sub regions are denoted (usually as percentages) by the appropriate efficiency defect ( $\delta_k$ ). The result presented in Figures 4 and 5 are obtained for condenser saturation temperature from 295 and 305 K respectively, assuming a constant ambient-temperature of 293 K. We see that for  $T_{cond} = 295K$ , the plant's rational efficiency is 29.52 %.



**Table: 5. Irreversibility Rates (kW) for the Stated Value of Condenser Temperature (K) ( $T_{cond}$ ); [ $T_{evap} = 249$ ]**

Component	305	303	301	299	297	295
Compressor	15.98	15.35	14.72	14.10	13.49	12.88
Throttle valve	2.1	1.94	1.79	1.64	1.51	1.37
Evaporator	5.89	5.89	5.89	5.89	5.89	5.89
Condenser	3.68	3.21	2.73	2.24	1.75	1.26
Total	27.67	26.40	25.14	23.89	22.65	21.42
Temp (K)	305	303	301	299	297	295

Data given in Figure 6, are determined at the extreme conditions [ $T_{evap} = 239$  K and  $T_{cond} = 305$  K]. At this condition the total efficiency defect in the system is 72.84 % where as the plant's rational efficiency is 27.16 %. The effect of variation of condenser and evaporator temperatures on irreversibility rates of system components are shown in Table 5 and 6 respectively. When the condenser temperature is varied from 295 K to 305 K, the total irreversibility rate in the system increases from 21.42 kW to 27.67 kW. The order of irreversibility rates (maximum to minimum) in system components are compressor, evaporator, throttle valve and condenser at 295 K. The irreversibility rates in compressor, condenser and throttle valve increases with increase in condenser temperature whereas for evaporator, it remains constant.

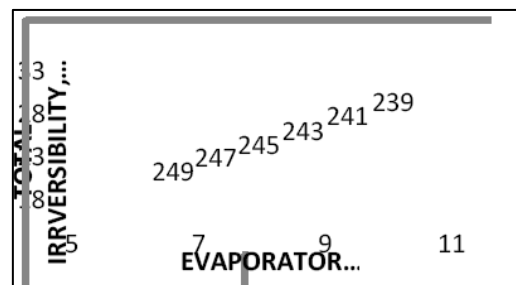
**Table: 6. Irreversibility Rates (kW) for the Stated Value of Evaporator Temperature  $T_{evap}$ ; for Condenser Temperature  $T_{cond} = 249$  K**

Component	249	247	245	243	241	239
Compressor	12.88	13.61	14.35	15.12	15.91	16.71
Throttle valve	1.37	1.51	1.64	1.8	1.96	2.13
Evaporator	5.89	6.56	7.24	7.94	8.64	9.36
Condenser	1.26	1.26	1.26	1.26	1.26	1.26
Total	21.42	22.95	24.53	26.14	27.78	29.5
Component	249	247	245	243	241	239

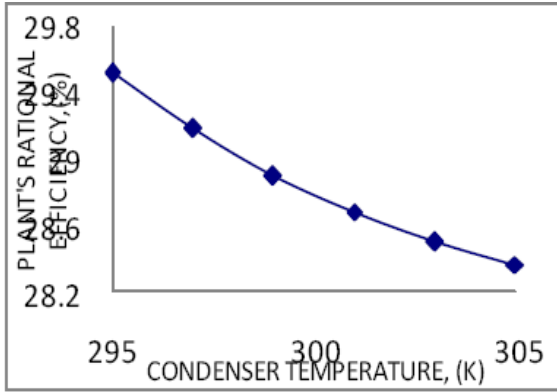
As shown in Table 6, when the evaporator temperature is varied from 249 K to 239 K, the total irreversibility rate in the system increases from 21.42 kW to 29.5 kW. The order of irreversibility rates (maximum to minimum) in system components are compressor, evaporator, throttle valve and condenser. The irreversibility rates in compressor, evaporator and throttle valve increases with decrease in evaporator temperature whereas for condenser, it remains constant. Figure 7 shows the variation of total irreversibility rate with condenser's irreversibility rate for different condenser temperature. As the condenser temperature increases, the condenser's irreversibility rate increases. For a unit change in condenser's irreversibility, the total irreversibility of the plant increases by 2.58. Figure 8 shows the variation of total irreversibility rate with evaporator's irreversibility rate for different evaporator temperature. As the evaporator

temperature decreases, the evaporator's irreversibility rate increases

**Fig: 8. Plot for Determining the CSB of the Condenser  $T_{evap}$  with as a Variable and  $T_{cond} = 249$  K**

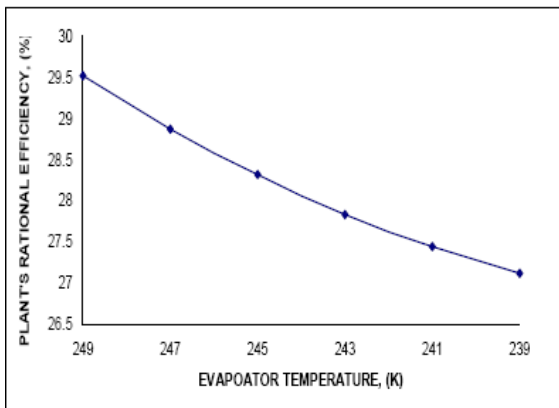


**Fig: 9. Plant's Rational Efficiency Dependence upon the Condenser Temperature**

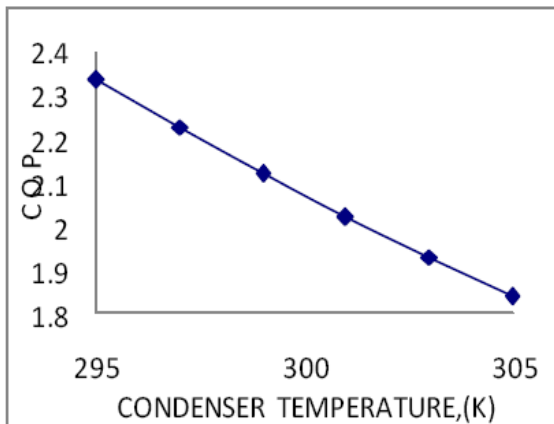


For a unit change in evaporator's irreversibility, the total irreversibility of the plant increases by 2.32

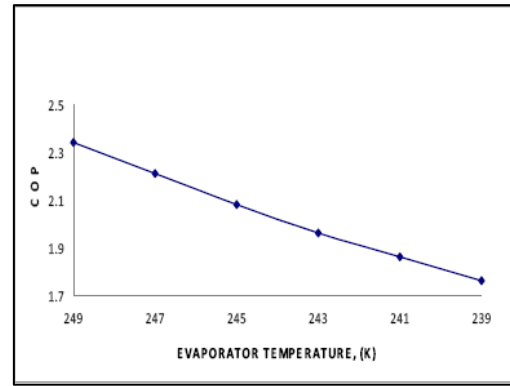
**Fig: 10. Plant's Rational Efficiency Dependence upon the Evaporator Temperature**



**Fig: 11. Plot between the COP vs. Condenser Temperature**



**Fig: 12. Plot between the COP vs. Evaporator Temperature**



The results presented in Figures 9 to 12 are obtained for different atmosphere conditions and Table 7 and 8 shows the variation of plant's rational efficiency with different temperature conditions.

**Table: 7(a). Irreversibility's and Plant's Rational Efficiencies for the Stated Values of  $T_{cond}$ ;  $T_{evap} = 249K$**

$(T_{cond})$ (K)	Total plant's irreversibility rate ( $I_t$ ) (kW)	Condenser's irreversibility rate ( $I_c$ ) (kW)	$(\eta)$ (%)
295	21.42	1.26	29.52
297	22.65	1.75	29.18
299	23.89	2.24	28.90
301	25.14	2.73	28.68
303	26.40	3.21	28.50
305	27.67	3.68	28.36

**Table: 7(b). Irreversibility's and Plant's Rational Efficiencies for the Stated Values of  $T_{cond}$ ;  $T_{evap} = 249 K$**

$(T_{cond})$ (K)	Total plant's irreversibility rate ( $I_t$ ) (kW)	Condenser's irreversibility rate ( $I_c$ ) (kW)	(COP)
295	21.42	1.26	2.34
297	22.65	1.75	2.23
299	23.89	2.24	2.12
301	25.14	2.73	2.02
303	26.40	3.21	1.93
305	27.67	3.68	1.84



**Table: 8a. Irreversibility's and Plant's Rational Efficiencies for the Stated Values of  $T_{evap}$  for given Condenser Temperature ( $T_{cond}$ ) = 295 K**

Evap Temp ( $T_{evap}$ ) (K)	Total plant's irreversibility rate ( $I_t$ ) (kW)	Evap's irreversibility rate ( $I_e$ ) (kW)	(COP)
249	21.42	5.89	2.34
247	22.95	6.56	2.21
245	24.53	7.24	2.08
243	26.14	7.94	1.96
241	27.8	8.64	1.86
239	29.5	9.36	1.76

**Table: 8b. Irreversibility's and Plant's Rational Efficiencies for the Stated Values of  $T_{evap}$  for  $T_{cond}$  = 295 (K)**

Evap temp ( $T_{evap}$ ) (K)	Plant's rational efficiency ( $\eta$ ) (%)	Evap. Temp ( $T_{evap}$ ) (K)	Total plant's irreversibility rate ( $I_t$ ) (kW)
249	29.52	249	21.42
247	28.87	247	22.95
245	28.31	245	24.53
243	27.83	243	26.14
241	27.44	241	27.8
239	27.11	239	29.5

The plant's rational efficiency and the COP decreases with increase in condenser temperature. Also with decrease in evaporator temperature with condenser temperature kept constant plant's rational efficiency decreases. The result indicates that available part of input energy (exergy) continuously decreases with increase in condenser temperature and decrease in evaporator temperature. From the pie chart (figure 3) we can see the percentages of irreversibility rate of different component of the system .By comparing different pie chart it is clear that contribution of compressor, evaporator, and condenser in total irreversibility is much larger than contribution of throttling device and also as the temperature of condenser rises, the irreversibility of each component rises. It can also be found out from the Figure 7 that there is direct linear relationship between total irreversibility and condenser irreversibility as the condenser temperature rises keeping the evaporator temperature constant. We

have also fined the effect of rational efficiency on condenser temperature keeping evaporator temperature constant. And it is being found out from the results that rational efficiency of plant decreases with increase in condenser temperature.

**5.0 Conclusions**

The analysis of the single stage vapour compression refrigeration plant's performance by the exergy method demonstrates how effective this method is for analyzing behavior. Employing the concepts of efficiency defect and rational efficiency has enabled the proportions of input lost through irreversibility's, in various plant sub regions, to be evaluated easily.

Using the technique of the coefficient of structural bond has demonstrated that a change in any component variable in a plant component significantly influences the other plant component in the plant as a whole, and a reduction of irreversibility's rate in a plant component give a greater reduction in the irreversibly rate of plant as whole. The greater the value of  $\Delta T$ , the greater the irreversibly. Because  $\Delta T_{cond}$  and  $\Delta T_{evap}$  affect the plant's rational efficiency, they need to be optimized each particularly heat transfer area chosen for the two heat exchanger.

**References**

[1] Moran M J, Availability Analysis: A guide to efficient energy use (Prentice Hall & engle wood Cliffs, NJ) 1982

[2] Szargut J,et.al, Energy analysis of thermal, chemical, and metallurgical processes (Hemisphere publishing corporation, Springer-Verlag, NJ) 1988

[3] T. J. Kotas, The exergy method of thermal plant analysis, 2nd edn, (Krieger publishing company, USA) 1995

[4] Bejan et.al, Thermal Design and Optimization, John Wiley & Sons, 1996

[5] M Kanoglu, Exergy analysis of the multistage cascade refrigeration cycle used for natural gas liquefaction, Int J Energy Res. 2002

- [6] A Bejan, Theory of heat transfer irreversible refrigeration plants, *Int J Heat mass transfer*, 32(9), 1989, 1631-39.
- [7] G Wall, Optimization of refrigeration machinery, *Int J Ref*, 14, 1999, 336-340
- [8] C. Nikolaidis, D. Probert, Exergy method analysis of a two stage vapour-compression refrigeration-plants performance, *Applied energy*, 60, 1998, 241-256
- [9] R Yumrutas, M. Kunduz, M Kanoglu, Exergy analysis of vapour compression refrigeration systems, *Exergy, an Int J*, 2, 2002, 266-272.

**Nomenclature**

A	Area (m <sup>2</sup> )
c	Constant
E <sub>Q</sub> <sup>D</sup>	Exergy rate, (kW)
h	Specific enthalpy, (kJ/kg)
h <sub>f</sub>	Enthalpy of saturated liquid refrigerant, (kJ/kg)
I	Irreversibility rate, (kW)
m <sub>R</sub>	Mass flow rate of refrigerant, (kg/s)
P	Pressure, (bar)
Q <sub>0</sub>	Heat transfer rate, (kW/m <sup>2</sup> K)
r	Compression ratio
s	Specific entropy, (kJ/kg K)
s <sub>f</sub>	Entropy of saturated liquid, (kJ/kg K)
T	Temperature, (K)
W	Work input, (kW)
X	Dryness fraction

**Greek Symbols (all dimensionless)**

$\eta_m$	Mechanical efficiency
$\eta_e$	Electric motor efficiency
$\sigma_{k,I}$	Coefficient of structural bonds
$\eta_R$	Rational efficiency
$\delta_k$	Efficiency defect

**Abbreviations**

COMP	Compressor
COND	Condenser
COP	Coefficient of performance
CSB	Coefficient of structural bond
EVAP	Evaporator
t	total